

--

Dato:
Kunde:
Projekt:



**131M**

Et-grebsblander med dobbelt svingbar tud.

131MUP = Et-grebsblander med keramisk ventilenhed 100.

131MAP = Greb NR28M, 250 mm dobbelt svingbar tud 030 med vandbesparende luftindblander, 60 mm dækroset 001, 3001.

Handicapvenlig.

**Flow**

	Bar:	1,0	2,0	3,0	4,0	5,0
131M	(l/min)	4,8	6,8	8,3	8,3	8,3

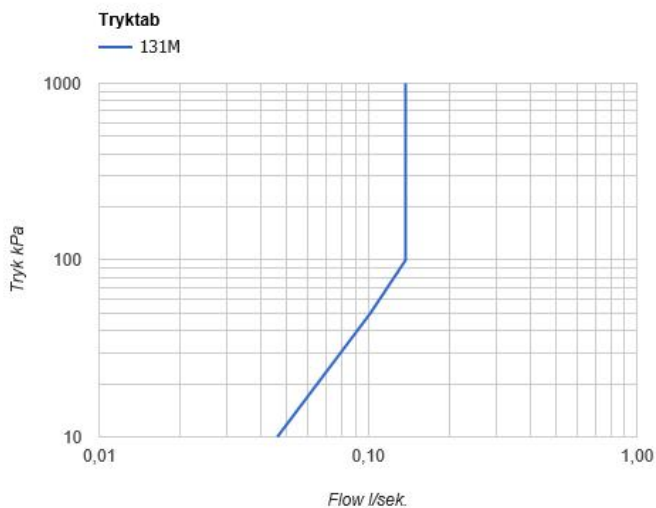

**Beskrivelse og tekniske data**

Montering	Armaturet kan bestilles med 15 mm CU rør påloddet tilgange for installation på cu-rørs installationer. Armaturet kan tilsluttes med medleveret 1/2" - 15 mm kompressionskoblinger og lekagesikringsboks til PEX-rør
Støjgruppe	Støjgruppe 1
Forudsat vandstrøm	0,20
Trykgruppe	Gruppe 300 kPa (Tryktabet over armaturet ved den forudsatte vandstrøm er mellem 150 og 300 kPa)

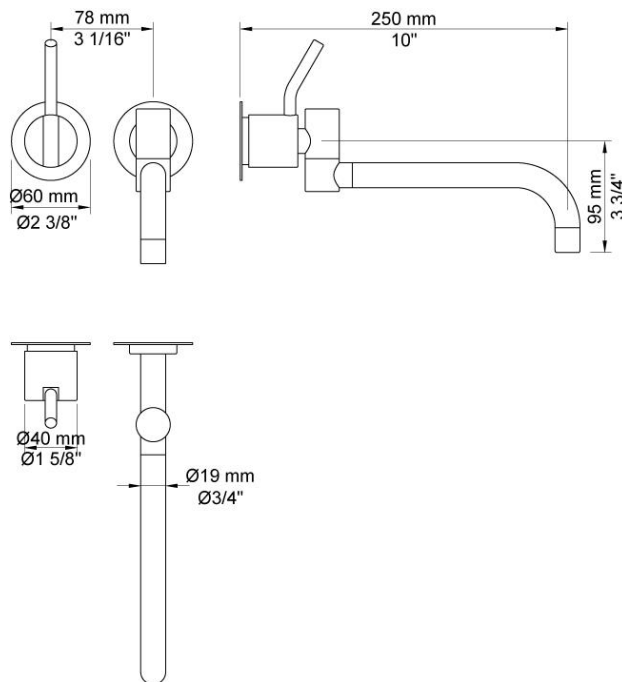

**Leveres i farverne**

Farve 02, Grå	Farve 21, Mørkerød
Farve 04, Blå	Farve 25, Pink
Farve 05, Orange	Farve 27, Mat-sort
Farve 06, Lysegrøn	Farve 28, Mat-hvid
Farve 08, Gul	Farve 40, Børstet Rustfrit stål
Farve 09, Koksgrå	Farve 60, Sort
Farve 12, Mokka	Farve 61, Børstet sort
Farve 14, Orange-rød	Farve 62, Dyb sort
Farve 15, Mørkeblå	Farve 63, Kobber
Farve 16, Krom	Farve 64, Børstet kobber
Farve 17, Blank sort	Farve 65, Guld
Farve 18, Hvid	Farve 68, Sølv
Farve 19, Messing natur	Farve 70, Børstet guld
Farve 20, Børstet krom	



**001**  
60 mm dækroset.  
Hul Ø30 mm.

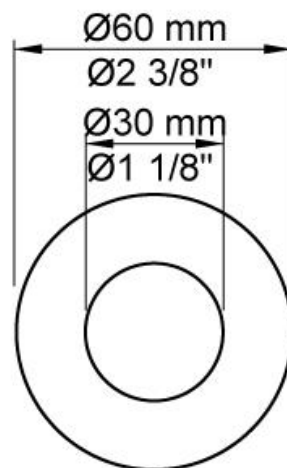

**030**  
250 mm dobbelt svingbar tud.

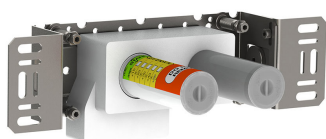
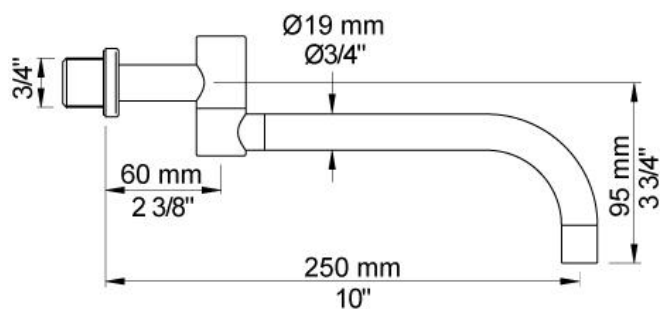

**100**  
Et-grebsblander med fast afgangsmuffe.  
Med pex-rørsikring.

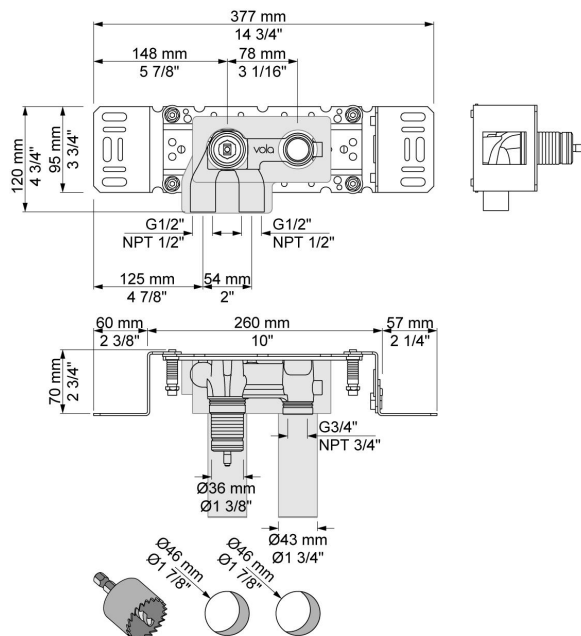

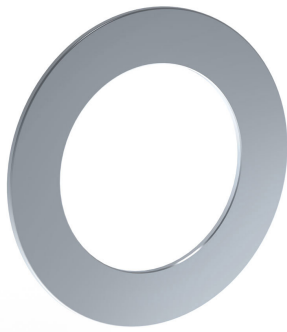
**3001**

60 mm dækroset.  
Hul  $\varnothing 36$  mm.

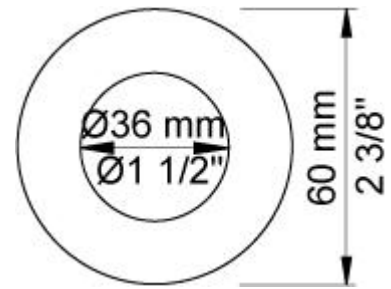
**NR28M**

Mellemlangt blandergrab til 100, 200, 300, 400.

